

**ROUND45**

**E 55 TOUCH**

**RAPID40**

**E 55 TOUCH**



**EN Use and Maintenance**

**CE**

49.0256.00  
ed. 11-2018

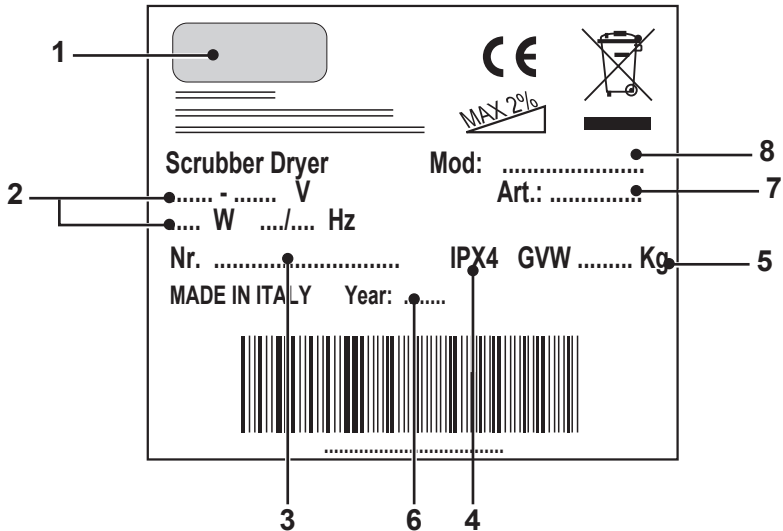
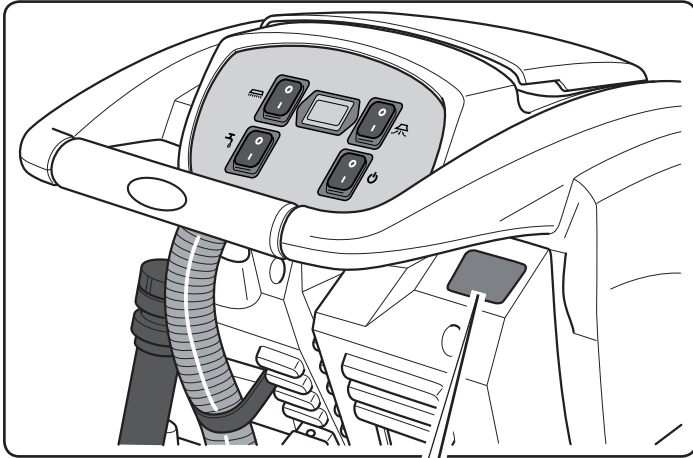

	1	2	3	4
IT	Produttore	Caratteristiche elettriche	N° Matricola	Grado di protezione
EN	Manufacturer	Electrical characteristics	Serial N°	Degree of protection
FR	Producteur	Caractéristiques électriques	N° Matricule	Degré de protection
DE	Hersteller	Elektrische Eigenschaften	Matrikelnr.	Schutzgrad
ES	Fabricante	Características eléctricas	N° Matricola	Grado de protección
PT	Produtor	Características elétricas	Número de série	Grau de protecção
NL	Producent	Elektrische eigenschappen	Serienummer	Beschermingsgraad
CS	Výrobce	Elektrické údaje	Výrobní č.	Úroveň ochrany
RU	Изготовитель	Электрические характеристики	Заводской №	Степень защиты
PL	Producent	Właściwości elektryczne	Nr. Fabryczny	Stopień ochrony
AR	الصانع	المواصفات الكهربائية	الرقم التسلسلي	درجة الحماية
NO	Produsent	Elektriske egenskaper	Matrikelnr.	Grad av beskyttelse
DK	Fabrikant	El-specifikationer	Matrikelnummer	Tæthedsgrad
SV	Tillverkare	Elektriska egenskaper	Serienummer	Grad av skydd

	5	6	7	8
IT	Peso in ordine di marcia	Anno di costruzione	Codice articolo	Modello
EN	Weight in running order	Year of manufacture	Item code	Model
FR	Poids en ordre de marche	Année de construction	Référence de l'article	Modèle
DE	Gewicht bei Betrieb	Baujahr	Artikelnummer	Modell
ES	Peso en orden de marcha	Año de fabricación	Código del artículo	Modelo
PT	Peso em ordem de marcha	Ano de construção	Código do artigo	Modelo
NL	Gewicht in rijklare toestand	Bouwjaar	Artikelcode	Model
CS	Hmotnost v provozním stavu	Rok výroby	Kód položky	Model
RU	Эксплуатационный вес	Год выпуска	Код изделия	Модель
PL	Ciężar w stanie pracy	Rok produkcji	Kod produktu	Model
AR	الوزن في وضعية التشغيل	سنة الصنع	رمز المنتج	الطراز
NO	Vekt i kjøreklar stand	Byggeår	Artikkelnummer	Modell
DK	Vægt i køreklar stand	Byggeår	Artikelkode	Model
SV	Vikt i körklart skick	Byggnadsår	Artikelnummer	Modell





English ..... ENGLISH - 1  
*(Translation of original instructions)*



*Dear Customer,  
Thank you for choosing one of our cleaning products.*

*The floor scrubber dryer that you have purchased has been designed to satisfy the user in terms of ease of use and reliability over time.*

*We are aware that in order for a good product to stay that way, over time, it requires continuous updates aimed at meeting the expectations of those who use it on a daily basis. For this reason, we hope that you will not only be a satisfied customer but also a partner who does not hesitate to give us your opinions and ideas originating from your personal day-to-day experience.*

# Index

<b>Technical data</b> .....	<b>ENGLISH-3</b>
<b>1.1 Introduction</b> .....	<b>ENGLISH-5</b>
<b>2.1 Getting to know the machine</b> .....	<b>ENGLISH-5</b>
<b>3.1 Unpacking</b> .....	<b>ENGLISH-5</b>
3.1.a - Standard machine equipment.....	ENGLISH-5
<b>4.1 Assembling the components</b> .....	<b>ENGLISH-5</b>
4.1.a - Wiper assembly .....	ENGLISH-5
4.1.b - Brush assembly .....	ENGLISH-5
<b>5.1 Control panel</b> .....	<b>ENGLISH-6</b>
<b>6.1 Filling the tank</b> .....	<b>ENGLISH-6</b>
<b>7.1 Operation</b> .....	<b>ENGLISH-7</b>
7.1.a - Checks before use.....	ENGLISH-7
7.1.b - Electrical connection .....	ENGLISH-7
7.1.c - Preparing the machine and choosing the cycle .....	ENGLISH-7
7.1.d - Using the machine .....	ENGLISH-8
7.1.e - Adjusting the movement direction.....	ENGLISH-8
7.1.f - Adjusting traction help.....	ENGLISH-8
7.1.g - End of use and switching off.....	ENGLISH-8
7.1.h - Maximum recovery tank water level alarm .....	ENGLISH-9
<b>8.1 Draining the recovery water</b> .....	<b>ENGLISH-9</b>
<b>9.1 Maintenance and cleaning</b> .....	<b>ENGLISH-9</b>
9.1.a - Emptying and cleaning the clean water tank .....	ENGLISH-9
9.1.b - Cleaning the recovery water tank .....	ENGLISH-10
9.1.c - Cleaning the squeegee .....	ENGLISH-10
9.1.d - Cleaning the clean water filter .....	ENGLISH-10
9.1.e - Replacing the brush.....	ENGLISH-10
9.1.f - Replacing the squeegee rubber blades .....	ENGLISH-11
9.1.g - Cleaning the recovery water tank .....	ENGLISH-11
9.1.h - Cleaning the suction filter .....	ENGLISH-11
9.1.i - Replacing the fuses .....	ENGLISH-11
9.1.l - Wiper adjustment .....	ENGLISH-11
<b>Troubleshooting</b> .....	<b>ENGLISH-12</b>
<b>10.1 Warranty</b> .....	<b>ENGLISH-13</b>
<b>Wiring diagram</b> .....	<b>ENGLISH-14</b>



## Technical data

	ROUND 45 E 55 TOUCH	RAPID 40 E 55 TOUCH
<b>Type of use</b>	Operator on ground	
<b>Characteristics</b>		
Power supply voltage	See technical data plate	
Installed load	1360 W	
Forward movement	Manual	
Washing width *	530 mm	
Drying width	750 mm	
Theoretical hourly efficiency	2120 m <sup>2</sup> /h	
<b>Brushes / Pad</b>		
Diameter / Number	530 mm / 21"x1	
Motor power / number	750 Wx1	
Motor speed	170 rpm	
Specific pressure	18,8 ÷ 22 gr/cm <sup>2</sup>	33 gr/cm <sup>2</sup>
Carter weight	29 ÷ 34 kg	--
<b>Aspiration</b>		
Motor power	600 W	
Negative pressure	1791 mmH <sub>2</sub> O	1250 mmH <sub>2</sub> O
Air flow rate	30 l / sec	
Noise level	63 dB	
<b>Tank</b>		
Recirculation	No	
Solution capacity	45 l	40 l
Recovery capacity	47 l	42 l
<b>Dimensions (lxwxh) without wiper</b>	1210 x 560 x 1040 mm	
<b>Vibrations ISO 5349 m/sec<sup>2</sup></b>	< 2,5	
<b>Weight</b>		
Empty weight	91,5 Kg	
Weight in running order GVW	136,5 Kg	131,5 Kg

\* The washing width is intended with the machine operating and the brush pressed down.

	<b>ROUND 45 E 55 TOUCH</b>	<b>RAPID 40 E 55 TOUCH</b>
<b>Accessories</b>		
0.7 ø PPL brush	40.0003.00 POLY 0,7	40.0003.00 POLY 0,7
Brush spray guard	24.0265.00 + 40.4003.00	24.0238.00 + 40.4004.00
Front rubber wiper element	39.0110.00	39.0110.00
Rear rubber wiper element	39.0111.00	39.0111.00
Water loading tube	30.0024.00	30.0024.00
Cable extension 25m	34.0427.00	--
<b>Optional accessories</b>		
0.9 ø PPL strong brush	40.0103.00 POLY 0,9	40.0103.00 POLY 0,9
1.2 ø PPL brush	40.0303.00	40.0303.00
1.2 ø tynex brush	40.0203.00	40.0203.00
Set polyurethane rubbers	95.0055.00	95.0055.00
Drive mechanism	40.1003.00	40.1003.00

## 1.1 INTRODUCTION



### DANGER:

Before using the machine, carefully read the attached “**SAFETY WARNINGS FOR THE FLOOR SCRUBBER DRYER**” manual.

## 2.1 GETTING TO KNOW THE MACHINE (Fig. 1)

- 1) Guide handle.
- 2) Control console.
- 3) Squeegee activation lever.
- 4) Water supply tap.
- 5) Solution tank.
- 6) Tank cover.
- 7) Clean water filling opening.
- 8) Wheels.
- 9) Splash guards.
- 10) Brush.
- 11) Squeegee.
- 12) Recovery water drain hose.
- 13) Squeegee water aspiration hose.
- 14) Recovery water tank.
- 15) Clean water drain/level tube.
- 16) Electric connection plug.
- 17) Clean water filter.
- 18) Brush up/down pedal.
- 19) Brush rotation activation button.
- 20) Touch sensor for the start-up and rotation of the brush.

## 3.1 UNPACKING (Figg. 1-2)

Once the packaging has been removed as shown in the instructions on the packaging itself, check that the machine and all the components supplied are intact.

If any evident damage is found, contact the area agent and the carrier within 3 days of receipt.

- Remove the bag (21) containing the accessories.
- Cut the strap (22).
- Remove the wooden blocks (23 and 24).
- Lift the brush flange (9) by pressing down on the pedal (19) (see relative paragraph).

- Lift the wiper support (25) by lifting the handle (3 Fig. 1) (see relative paragraph).
- Position a chute and unload the machine from the bench.

### 3.1.a - Standard machine equipment (Fig. 3)

The accessories supplied are as follows:

- 10) Brush/brushes.
- 11) Wiper.
- 26) Water filling hose.
- 27) Machine use and maintenance manual.
- 28) Anti-tear hook.
- 29) Fuses.
- 30) Filter for clean water tank opening.

## 4.1 ASSEMBLING THE COMPONENTS

### 4.1.a - Wiper assembly (Fig. 4)

- Loosen the two handwheels (31) located on the wiper (11).
- Assemble the wiper (11) on the support (25), tightening the two handwheels (31).
- Connect the tube (13) to the wiper connector (32).



### **N.B.:**

Perform the previous operations with the wiper support lowered.

### 4.1.b - Brush assembly (Fig. 5)





### HAZARD:

**Operation to be performed by two people!**

- Raise the splash guard (9) and remove the polystyrene protection (33).
- Assemble the brush as described in the paragraph “replacing the brush”.

## 5.1 CONTROL PANEL (Fig. 9)

### 20) Sensor for the start of the rotation of the brush

Acting on the touch sensor (20) with switch (34) “”, the switch (38) “” and the switch (39) “” inserted, it starts the rotation of the brush and the water supply.

### 34) Main switch

With the plug inserted, it lights up, indicating the presence of voltage.  
Pressed in “I” position, it gives the voltage to other switches.  
Pressed on “0” it stops.

### 35) Suction unit activation switch

The operation of the switch is enabled by the switch (34) in position “I”.  
By pressing the power switch to “I” starts the operation of the vacuum.

### 37) Operating hour indicator

Indicates the machine operating hours.

### 38) Brush rotation enabling switch

Press the switch (38), it enables the rotation of the brush; the operation of the same is controlled by the touch sensor (20). To disable the rotation of the brush, press the switch (38) “”.

### 39) Water solenoid valve switch

The operation of the switch is enabled by the switch (38) in position “I”.  
Press the switch (39), it prepares the opening of the solenoid water, the operation thereof is controlled by the touch sensor (20).

The amount of water is controlled by the tap (4).

### 4) Water quantity adjustment tap

Turn the tap (4) counter-clockwise to increase the quantity of water or turn it clockwise to decrease it.

## 6.1 FILLING THE TANK (Fig. 7)



### WARNING:

**Only add clean mains water to the tank at a temperature no greater than 50°C.**

- Remove the hose (26) supplied, connect one end (26a) to a tap and insert the other end (26b) in the tank (5).
- Check that the tap (40) is open.
- Turn on the tap and fill the tank (5) to the **MAXIMUM LEVEL (NOT EXCEED)** indicated by the label placed on the transparent tube (15).
- Pour the liquid detergent into the tank for machines not equipped with chemical kit.



### N.B.:

Use non-foamy detergents only. For the quantities, follow the instructions provided by the detergent manufacturer according to the type of dirt.



### DANGER:

**If the detergent comes in contact with the eyes and/or skin or if swallowed, refer to the use and safety information booklet provided by the manufacturer of the detergent.**

## 7.1 OPERATION (Fig. 8)

### 7.1.a - Checks before use

- Check that the exhaust tube (12) of the recovery tank is properly coupled and properly sealed.
- Check that the connector (41) on the squeegee (11) is not blocked and that the hose is connected correctly.
- Check that the clean water exhaust tube (15) is correctly coupled to the supports and that the tap (40) is open.

### 7.1.b - Electrical connection

- Introduce the cable (42) of an extension in the tear-proof hook (28) locking it as shown in figure.
- Connect the outlet (43) of the extension cord (42) with the plug (16) of the machine.
- Connect the power cord to an outlet having minimum capacity of 10A.



#### **WARNING:**

- **Make sure that the mains system is equipped with an RCD (circuit breaker).**
- **Unwind the electric power cable completely before operating the appliance.**
- **Use an electrical extension lead only if in perfect condition; ensure that the section is appropriate for the appliance power rating.**
- **Never let the power cable run over sharp edges and do not tread on it.**

### 7.1.c - Preparing the machine and choosing the cycle (Fig. 6-9)

- Press the switch (34 Fig. 6).
- Release the lever (3 Fig. 9) and lower it; the floor squeegee (11 Fig. 9) is lowered.
- Press down on the pedal (19 Fig. 9), release it from its coupling and lift it, the brush (10 Fig. 1) will be lowered.



#### **NOTE:**

*The brush has two working positions:*

#### **Normal position "A"**

*It is automatically placed when you release the pedal (19 Fig. 9) from the lifted position.*

#### **Position for persistent dirt "B"**

*From the "A" working position, lift the pedal (19 Fig. 9) and engage it in the "B1" holder: an additional pressure of 5 kg will be exercised on the brush.*

#### **Working cycle:**

- The machine can perform 4 working cycles:

#### **Drying only cycle:**

- In order to perform the drying cycle alone, press the switch (35). The suction unit will activate.

#### **Brushing only cycle:**

- To perform only the brushing cycle, press the switch (38) to enable brush rotation. Touch the touch sensor to start the rotation of the brush.

#### **Washing, brushing cycle:**

- Press the switch (38) to enable brush rotation, press the switch (39) to enable water dispensing. Touch the touch sensor to start the rotation of the brush and the water supply.

#### **Washing, brushing, drying cycle:**

- Press the switch (35) to start the aspirator, switch (38) to enable brush rotation and press the switch (39) to enable water dispensing. Touch the touch sensor to start the rotation of the brush and the water supply.

**7.1.d - Using the machine (Fig. 1)**

- After turning the machine on and selecting the cycle, the cleaning operation starts, pushing the machine with the help of the handle (1).

**N.B.:**

Pay attention to particularly delicate floors; do not use the machine while it's stopped and the brush rotation on.

**N.B.:**

The proper cleaning and drying of the floor is done by pushing the machine forwards; if you go backwards the machine will not perform drying; in this phase, always lift the wiper to avoid damaging the blades.

- If necessary, adjust the quantity of washing water using the tap (4 Fig. 1).

**7.1.e - Adjusting the movement direction (Fig. 10)**

If during the cleaning operation (rotating brushes) we notice that the machine is not moving in a straight line, but tends to go left or right, you can adjust the direction of the wheels (44).

- Start the machine and begin the rotation of the brushes.  
If the car tends to go to the right, gently turn the wheel button (44) to "S" until the direction is right;  
If the car tends to go to the left, gently rotate the wheel button (44) to "D" until the direction is right.

**7.1.f - Adjusting traction help (Fig. 10)**

The function of the hand wheel (45) is to increase / decrease the ground pressure of the brush in order to facilitate thrusting forward the machine.

- Turning the hand wheel (45) clockwise will decrease traction adjustment and conversely it will increase it.

**7.1.g - End of use and switching off (Fig. 6-11)**

- Once the cleaning operations have been completed, do not shut off the machine immediately: use switches (39) and (38) to deactivate water dispensing and brush rotation.
- Lift up the brush by pressing the pedal (19 Fig. 11) as far as it will go, fitting it in the designated slot.
- Continue with the aspirator inserted to aspirate all the liquid on the floor, then turn off the aspirator by pressing the switch (35 Fig. 6).
- Lift the squeegee (11 Fig. 11) by lifting the lever (3 Fig. 11).

**WARNING:**

**Always lift the wiper and the end piece after finishing the cleaning operations because this avoids the deformation of the rubber blades and of the brush hairs.**

- Press the switch (34 Fig. 6) on "0" to turn off the machine.
- Disconnect the plug from the socket.

## 7.1.h - Maximum recovery tank water level alarm

If during use of the machine, the vacuum cleaner turns off, it means that the level of liquid in the recovery tank has reached the maximum level.

Go to the water drainage station and drain the recovery tank as shown in the relative paragraph.



### NOTE:

*For the proper operation of the level sensors it is required to properly clean the inside of the tank (14 Fig. 14).*

## 8.1 DRAINING THE RECOVERY WATER (Fig. 12)

At the end of the washing cycle or when the recovery water tank (14) is full, it is necessary to empty the tank by proceeding as follows:



### N.B.:

*To dispose of the recovery water, comply with the standards in force in the country in which the machine is used.*

- Position the machine near to a drain outlet.
- Disconnect the hose (12) from the support.
- Remove the cap (46) from the hose (12) and drain all the water contained in the tank.



### N.B.:

*The amount of water that comes out can be modulated by pressing on the end of the tube (12).*

- Screw the cap (46) back on the tube (12) and put it back on its support.

## 9.1 MAINTENANCE AND CLEANING



### WARNING:

**All maintenance operations must be performed with the machine off and tanks empty.**

## OPERATIONS TO PERFORM DAILY

### 9.1.a - Emptying and cleaning the clean water tank (Fig. 13)



### WARNING:

**At the end of the washing operations, it is compulsory to drain and clean the clean water tank (5) to prevent deposits or scaling.**

After draining the recovery water tank, drain the clean water tank as follows:

- Position the machine over a drain outlet.
- Disconnect the tube (15) from the hooks, close the tap (40), lower the tube to the ground on the drain outlet, open the tap (40) and let the water drain completely.
- Wash the inside of the tank, leaving the drain hose open and adding clean water through the top opening.
- When cleaning is complete, lift the tube (15), leaving the tap (40) open; couple the tube in its recesses.
- To completely drain the water from the tank (5) disconnect the tube (47) from the quick connector (48) then turn the connector downwards, letting the water drain completely; or remove the filter cover (49).

### 9.1.b - Cleaning the recovery water tank (Fig. 14)



#### WARNING:

At the end of the washing operations, it is compulsory to clean the recovery water tank to prevent deposits or scaling and the proliferation of bacteria, odours or mould.

- Drain the recovery water as shown in the relative paragraph, positioning the machine over a drain outlet.
- Remove the cover (6).
- Leaving the hose (12) lowered and the cap off, pour water into the tank (14) through a hose, cleaning it until clean water comes out of the drain hose.
- Replace all the components in reverse order.

### 9.1.c - Cleaning the squeegee (Fig. 4)

In order to clean the squeegee correctly (11), it is necessary to remove it as follows:

- Disconnect the hose (13) from the squeegee (11).
- Loosen the knobs (31) and remove the squeegee (11).
- Wash the squeegee and in particular the rubber blades (50) and the inside of the aspiration connector (32).



#### N.B.:

If, during washing, it is clear that the rubber blades (50) are damaged or worn, it is necessary to replace them or turn them over.

- Replace all the components in reverse order.

## OPERATIONS TO PERFORM WHEN NECESSARY

### 9.1.d - Cleaning the clean water filter (Fig. 15)



#### NOTE:

Before cleaning the filter, make sure the clean water tank is empty.

- Unscrew and remove the cover (49).
- Remove the filter (17) and wash it in running water.
- Refit the filter (17) in its seat, then tighten the cover (49).

### 9.1.e - Replacing the brush (Fig. 6-16)

It is necessary to replace the brush when it is worn more than 2 cm or it must be replaced depending on the type of floor to be washed; to replace it proceed as follows:

- Lift up the brush using the pedal as shown in the relative paragraph.
- Insert a hand under the brush holder unit (51 Fig. 16); to release the brush, turn it abruptly in the direction of rotation.
- Replace the brush, coupling it manually to the brush holder flange (51 Fig. 16).
- Lower the brush, acting on the pedal, as shown in the respective section.
- Press switch (34 Fig. 6) to position "1".
- Press the switch (38 Fig. 6) to enable the rotation of the brushes.
- Act on the touch sensor (20) positioned on the handle to start the rotation of the brush.
- Turn off the machine by pressing the switch (34 Fig. 6) on "0".



### 9.1.f - Replacing the squeegee rubber blades (Fig. 17)

When it becomes clear that drying the floor is difficult or traces of water remain on the floor, it is necessary to check the wear on the squeegee rubber blades (50):

- Remove the squeegee unit (11) as indicated in the "Cleaning the squeegee" paragraph.
- Press the locking device (52) and open the handle (53).
- Remove the two rubber mounting strips (54) and remove the outer rubber (55).
- Loosen the two turnbuckles (56) and remove the locking bar (57) and the inside rubber (58).



#### **N.B.:**

When the rubber blades (55) or (58) are worn on one side, on one occasion they may be turned over.

- Replace or turn over the rubber blades (55) or (58) without inverting them.
- Replace all the components in reverse order.



#### **N.B.:**

It is possible to have two types of rubber blade.

Para rubber blades for all types of floor and polyurethane rubber blades for mechanical workshop floors which are dirty with oil.

### 9.1.g - Cleaning the recovery water tank (Fig. 18)

Remove the upper cover to access inside the recovery water tank.

- Loosen the knob (59) and remove the filter (60).
- Wash the filter (60) with running water and replace it in the machine, tightening the knob (59).
- If the filter (60) is particularly dirty you can open it by levering with a screwdriver on the coupling claw (61).

### 9.1.h - Cleaning the suction filter (Fig. 18)

- Lift the filter with its cover (62).
- Loosen the screw (63) and remove the filter (64).
- Wash the filter (64) in running water and reassemble it in reverse order.

### 9.1.i - Replacing the fuses (Fig. 8-19)



#### **WARNING:**

**Replace the blown fuse with one with the same amperage.**

- Remove the plug (16 Fig. 8) from the socket (43 Fig. 8).
- Remove the cover (65 Fig. 19) unscrewing the screws (66 Fig. 19) to access the fuse.
- Remove the cover sheet and replace the fuse. Put the cover (65 Fig. 19) back.

### 9.1.l - Wiper adjustment (Fig. 20)

- It is possible to adjust the height of the wiper and adjust the incidence of the blades on the floor.

#### **Height adjustment (only if necessary)**

- The height is adjusted at the time of construction of the machine, then change it only when absolutely necessary.
- Loosen the screw (67) and lift or lower the wheel (68) until the wiper is in the desired position, then tighten the screw (67).

#### **Incidence adjustment**

- Lower the wiper, using the lever.
- Start the aspirator and proceed for a few metres, then turn off the aspirator and stop the machine.
- Check the incidence of the rubber (50) blades.

**Fig. A** = too low

**Fig. B** = too high

**Fig. C** = correct position

- Use the grey knob (69) for adjustment, turning it anticlockwise to increase the incidence and in the other direction to decrease it.

**TROUBLESHOOTING**

<b>PROBLEM</b>	<b>CAUSE</b>	<b>SOLUTION</b>
Pressing the switch (34), the machine will not turn on.	Circuit switch to position "0". Switch failure. Power cable disconnected.	Press the power switch. Replace the switch. Connect the cable.
The brush does not rotate.	Function card damaged. Brush motor damaged. Switch failure. Brush rotation enabling switch not pressed.	Replace. Replace. Replace the switch. Press the switch.
Aspirator does not work.	Function card damaged. Intake motor damaged. Switch failure. Suction unit switch not pressed. Recovery tank full.	Replace. Replace. Replace the switch. Press the switch. Drain, flush and clean the tank.
The machine does not dry well, leaving traces of water on the floor.	Aspirator off. Switch failure. Aspiration tube blocked. Dirty wiper. Recovery tank full. Dirty water filter clogged. Squeegee rubber blades worn.	Start up the aspirator. Replace the switch. Check and if necessary clean the aspiration tube that connects the squeegee to the recovery tank. Clean the wiper. Empty the recovery tank. Clean the filter. Replace or turn over the squeegee rubber blades.

<b>PROBLEM</b>	<b>CAUSE</b>	<b>SOLUTION</b>
No water comes out.	Tank empty. Switch failure. Solenoid valve enabling switch not pressed. Tap turned off. Filter blocked. Solenoid valve does not work.	Fill the tank. Replace the switch. Press the switch. Open the tap Clean the filter. Call the technical support service.
Insufficient floor cleaning.	Unsuitable brushes or detergent. Brush worn.	Use brushes or detergents which are suitable for the type of floor or dirt to be cleaned. Replace the brush.
The brush does not rotate. Aspirator does not work. No water comes out.	Faulty sensor.	Replace.

## **10.1 WARRANTY**

During the warranty period all defective parts will be repaired or replaced, free of charge. All parts affected by tampering or misuse will be excluded from the warranty. In order to enable the warranty procedure please contact your dealer or a relevant service center by presenting the valid purchase documents.

# WIRING DIAGRAM

## ROUND 45 E 55 TOUCH - RAPID 40 E 55 TOUCH

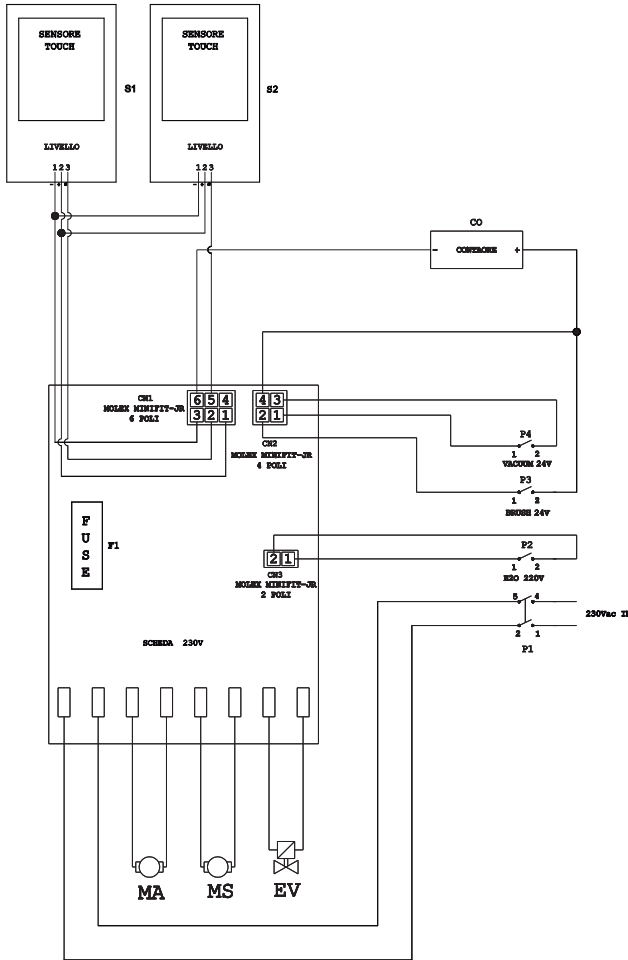

CO .....Hour counter  
 CN 1 .....sensor board 6-pole connector  
 CN 2 .....circuit board 4-pole connector  
 CN 3 ..... EV circuit board 2-pole connector  
 F1 ..... Fuse  
 MA ..... Vacuum motor  
 MS ..... Brush motor  
 EV ..... Solenoid  
 P1 ..... 230V Bipolar switch  
 P2 ..... EV Switch  
 P3 ..... Brush switch  
 P4 ..... Vacuum switch

S1 ..... Recovery level touch sensor  
 S2 ..... Magnetic sensor  
**Sensore Touch** ..... Handle touch sensor  
**Livello** ..... Level  
**Scheda 230V** ..... 230V board







DEALER

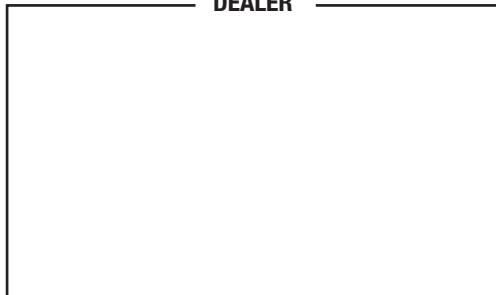

Cod. 49.0256.00 - 2<sup>a</sup> ed. - 11/2018

**Ghibli & Wirbel S.p.A.**

Via Circonvallazione, 5 - 27020 Dorno PV - Italia  
P. +39 0382 848811 - F. +39 0382 84668 - M. info@ghibliwirbel.com

**[www.ghibliwirbel.com](http://www.ghibliwirbel.com)**

**100% MADE IN ITALY**

**A COMPANY GROUP OF RIELLO INDUSTRIES**

