

# RACER / RANGER

R 85 FD 65

R 85 FD 75

R 115 FD 75

R 115 FD 85







**EN** Use and Maintenance

**CE**

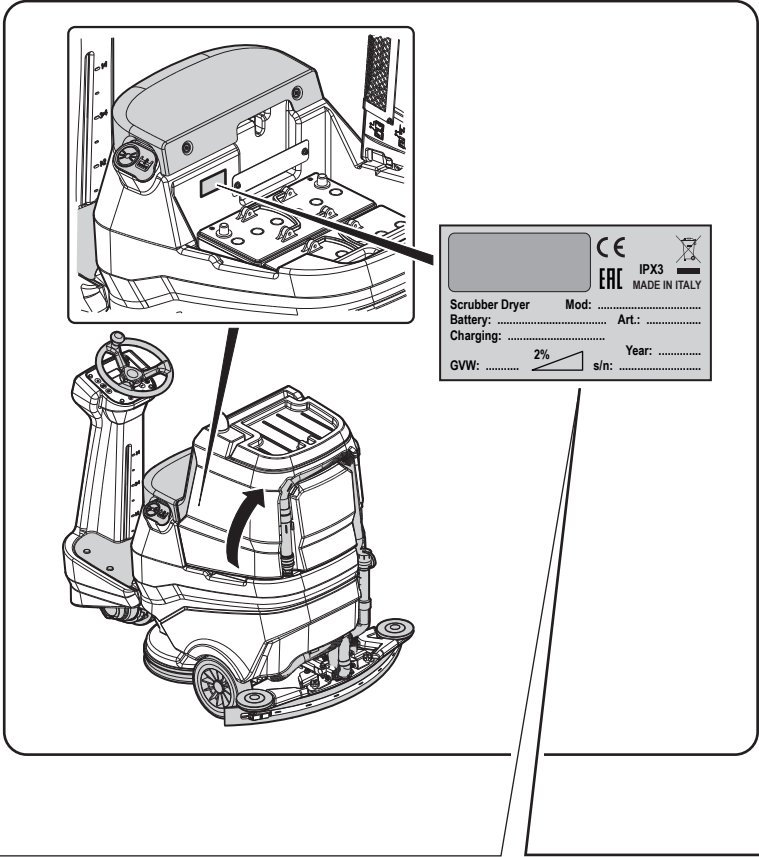



49.0335.00  
ed. 04/2026





Scrubber Dryer Mod: .....  
 Battery: .....V .....W Art.: .....  
 Charging: .....  
 GVW: ..... 2% s/n: ..... Year: .....

1 

2 • Scrubber Dryer Mod: ..... 8  
 • Battery: .....V .....W Art.: ..... 7  
 • Charging: .....

GVW: ..... 2% s/n: ..... Year: ..... 6  
 5 9 3

	1	2	3
IT	Produttore	Caratteristiche elettriche	N° Matricola
EN	Manufacturer	Electrical characteristics	Serial N°
FR	Producteur	Caractéristiques électriques	N° Matricule
DE	Hersteller	Elektrische Eigenschaften	Serien-Nr.
ES	Fabricante	Características eléctricas	N° Matricola
PT	Produtor	Características eléctricas	Número de série
NL	Producent	Elektrische eigenschappen	Serienummer
CS	Výrobce	Elektrické údaje	Výrobní č.
RU	Изготовитель	Электрические характеристики	Заводской №
PL	Producent	Specyfikacja elektryczna	Numer seryjny
AR	الصانع	المواصفات الكهربائية	الرقم التسلسلي

	4	5	6
IT	Grado di protezione	Peso in ordine di marcia	Anno di costruzione
EN	Degree of protection	Weight in running order	Year of manufacture
FR	Degré de protection	Poids en ordre de marche	Année de construction
DE	Schutzgrad	Gewicht bei Betrieb	Baujahr
ES	Grado de protección	Peso en orden de marcha	Año de fabricación
PT	Grau de protecção	Peso em ordem de marcha	Ano de construção
NL	Beschermingsgraad	Gewicht in rijklare toestand	Bouwjaar
CS	Úroveň ochrany	Hmotnost v provozním stavu	Rok výroby
RU	Βαθμός προστασίας	Βάρος στην λειτουργία	Έτος κατασκευής
PL	Stopień zabezpieczenia	Ciężar podczas eksploatacji	Rok produkcji
AR	درجة الحماية	الوزن في وضعية التشغيل	سنة الصنع

	7	8	9
IT	Codice articolo	Modello	Massima pendenza superabile
EN	Item code	Model	Maximum superable slope
FR	Référence de l'article	Modèle	Pente maximum surmontable
DE	Artikelnummer	Modell	Maximal befahrbare Steigung
ES	Código del artículo	Modelo	Máxima pendiente que se puede superar
PT	Código do artigo	Modelo	Máximo declive transponível
NL	Artikelcode	Model	Maximaal berijdbare hellingsgraad
CS	Kód položky	Model	Maximální překonatelný sklon
RU	Код изделия	Модель	Максимальный преодолимый наклон
PL	Kod artykułu	Model	Maksymalnie superable stoku
AR	رمز المنتج	الطراز	أقصى درجة ميلان قابلة للتخطي



**EN**

English .....EN - 1  
(*Translation of original instructions*)



*Dear Customer,  
Thank you for choosing one of our cleaning products.*

*The floor scrubber dryer that you have purchased has been designed to satisfy the user in terms of ease of use and reliability over time.*

*We are aware that in order for a good product to stay that way, over time, it requires continuous updates aimed at meeting the expectations of those who use it on a daily basis. For this reason, we hope that you will not only be a satisfied customer but also a partner who does not hesitate to give us your opinions and ideas originating from your personal day-to-day experience.*

# INDEX

<b>INDEX</b> .....	<b>2</b>
<b>TECHNICAL DATA</b> .....	<b>3</b>
<b>1.1 - INTRODUCTION</b> .....	<b>4</b>
1.1.a - Operator position .....	4
1.1.b - General warnings while using the machine .....	5
<b>1.2 - NON-INTENDED MACHINE USE</b> .....	<b>5</b>
<b>2.1 - GETTING TO KNOW THE MACHINE (Fig. A)</b> .....	<b>5</b>
<b>3.1 - UNPACKING (Fig. B)</b> .....	<b>5</b>
3.1.a - Battery installation (Fig. A).....	5
3.1.b - Unloading the machine from the wooden pallet (Fig. B).....	6
<b>4.1 - ASSEMBLY COMPONENTS</b> .....	<b>6</b>
4.1.a - Squeegee installation (Fig. C) .....	6
4.1.b - Brushes installation .....	6
<b>5.1 - CHARGING THE BATTERY</b> .....	<b>6</b>
5.1.a - Charging the battery with an external battery charger (Fig. G) .....	7
5.1.b - Battery charging with on-board battery charger (if present) (Fig. G).....	7
<b>6.1 - MACHINE CONTROLS</b> .....	<b>7</b>
6.1.a - Control panel (Fig. F).....	7
6.1.b - Accelerator pedal (Fig. A) .....	9
<b>7.1 - DISPLAY (Fig. F)</b> .....	<b>10</b>
<b>8.1 - EMERGENCY</b> .....	<b>11</b>
<b>9.1 - SAFETY DEVICES (Fig. A)</b> .....	<b>11</b>
<b>10.1 - FILLING THE TANK (Fig. D)</b> .....	<b>11</b>
<b>10.2 - DETERGENT CHEMICAL TANK (if present) (Fig. E)</b> .....	<b>12</b>
<b>11.1 - OPERATION (Fig. A-F)</b> .....	<b>12</b>
11.1.a - Checks before use.....	12
11.1.b - Preparing the machine and choosing the cycle.....	12
11.1.c - Using the machine.....	13
11.1.d - End of use and shutdown .....	13
<b>12.1 - DRAINING THE RECOVERY WATER (Fig. H)</b> .....	<b>14</b>
<b>13.1 - MAINTENANCE AND CLEANING</b> .....	<b>14</b>
<b>13.2 - OPERATIONS TO PERFORM DAILY</b> .....	<b>14</b>
13.2.a - Emptying and cleaning the clean water tank (Fig. I).....	14
13.2.b - Cleaning the recovery water tank (Fig. J).....	15
13.2.c - Squeegee cleaning (Fig. K).....	15
<b>13.3 - OPERATIONS TO BE PERFORMED EVERY 3 MONTHS</b> .....	<b>15</b>
13.3.a - Check the wear status of the steering chain (Fig. L) .....	15
<b>13.4 - OPERATIONS TO PERFORM WHEN NECESSARY</b> .....	<b>15</b>
13.4.a - Brushes replacement (Fig. M) .....	15
13.4.b - Splash guard rubber adjustment (Fig. M).....	16
13.4.c - Replacing the squeegee rubber blades (Fig. K) .....	16
13.4.d - Squeegee incidence adjustment (Fig. N) .....	16
13.4.e - Squeegee pressure adjustment (Fig. O) .....	17
13.4.f - Cleaning the clean water filter (Fig. P) .....	17
13.4.g - Battery compartment drain tap (Fig. A).....	17
13.4.h - Checking the wear status of the three wheels (Fig. A) .....	17
<b>14.1 - PARAMETER SETTING (Fig. F)</b> .....	<b>18</b>
14.1.a - OPERATOR parameters.....	18
<b>15.1 - FUSE CHECK/REPLACEMENT</b> .....	<b>20</b>
<b>16.1 - ALARMS DURING THE FUNCTIONING (Fig. F)</b> .....	<b>20</b>
<b>17.1 - TROUBLESHOOTING</b> .....	<b>23</b>
<b>18.1 - DEMOLITION OF THE MACHINE</b> .....	<b>24</b>
<b>19.1 - WIRING DIAGRAM</b> .....	<b>25</b>

## TECHNICAL DATA

	RACER R 85		RANGER R 115	
	FD 65	FD 75	FD 75	FD 85
<b>Driving type</b>	Ride-on			
<b>Features</b>				
Operation and Supply	Battery 24 V			
Type of batteries	N° 2 - 12V 105Ah (C5)		N° 4 - 6V 240Ah (C5)	
	N° 4 - 6V 180Ah (C5)		N° 1 - 24V 320Ah (C5)	
Installed power	2160 W		2210 W	
Running time	2 h (105Ah C5)		5 h (240Ah C5)	
	4 h (180Ah C5)		7 h (320Ah C5)	
Advancement	Forward / reverse drive			
Washing track width	650 mm	750 mm	750 mm	850 mm
Suction width	850 mm	950 mm	950 mm	1050 mm
Productivity theoretical	4000 m <sup>2</sup> /h	4500 m <sup>2</sup> /h	4500 m <sup>2</sup> /h	5000 m <sup>2</sup> /h
Productivity practical	2400 m <sup>2</sup> /h	2700 m <sup>2</sup> /h	2700 m <sup>2</sup> /h	3000 m <sup>2</sup> /h
Hand-arm vibration system (ISO 5349-1)	< 2,5 m/s <sup>2</sup>			
Whole body vibration (ISO 2631-1)	< 0,5 m/s <sup>2</sup>			
Sound pressure (ISO 11203) (LpA)	63 dB(A)			
Sound pressure in silent mode (LpA)	57 dB(A)			
IP code	IPX3			
<b>Brushes</b>				
Diameter / pad / number	330 mm / 13" / 2	380 mm / 15" / 2	380 mm / 15" / 2	430 mm / 17" / 2
Motor power / number	500 W / 2			
Brush speed	165 rpm			
Specific pressure	30 gr/cm <sup>2</sup>	21 gr/cm <sup>2</sup>	21 gr/cm <sup>2</sup>	17 gr/cm <sup>2</sup>
Specific pressure (extra pressure)	46 gr/cm <sup>2</sup>	32 gr/cm <sup>2</sup>	43 gr/cm <sup>2</sup>	34 gr/cm <sup>2</sup>
<b>Traction</b>				
Maximum slope of use during work	2 %			
Maximum slope when empty (*)	12 %			
Drive motor power	600 W			
Maximum forward speed	6 km/h			
<b>Suction</b>				
Motor power	550 W			
Depression (water column)	125 mbar / 1250 mmH <sub>2</sub> O			
Air flow	30 l/sec			

	RACER R 85		RANGER R 115	
	FD 65	FD 75	FD 75	FD 85
<b>Tank</b>				
Typology	Double tank			
Solution capacity	80 l		110 l	
Recovery capacity	85 l		115 l	
<b>Dimensions</b>				
Machine dimensions (length x width x height)	1375 x 705 x 1230 mm		1470 x 770 x 1365 mm	
Machine width - Brushes deck	715 mm	785 mm	785 mm	890 mm
Machine width - squeegee	885 mm	950 mm	950 mm	1055 mm
Battery compartment dimensions (length x width x height)	380 x 540 x 310 mm		380 x 625 x 440 mm	
<b>Weight</b>				
Empty weight	213 kg		246 kg	
Weight with Gel 12V 105Ah batteries	285 kg		-	
Weight with Gel 6V 180Ah batteries	333 kg		-	
Weight with Gel 6V 240Ah batteries	-		432 kg	
Weight with Pb Wet 24V 320Ah battery	-		506 kg	
Gross vehicle weight (GVW)	490 kg		691 kg	

(\*) The machine was tested under the following conditions:

- Standard battery
- Empty tanks
- Raw concrete ramp
- Ramp length 15 m
- 75 kg of operator

## 1.1 - INTRODUCTION



### **NOTE:**

*The numbers and the figure references shown in brackets refer to the components indicated in the annexed illustrative sheet.*



### **DANGER:**

**Before using the machine carefully read the “SAFETY WARNINGS FOR**

**FLOORS WASHER-DRYER” manual annexed to this one and the additions indicated below.**

### **1.1.a - Operator position**

The operator, during the machine use is sitting on the seat with his hands on the steering wheel.

### 1.1.b - General warnings while using the machine

- DO NOT leave the machine unattended on inclined surfaces.
- It is absolutely forbidden to turn while on ramps; danger of tipping/overturning.
- Avoid using the machine in environments where there is a risk of falling objects.

### 1.2 - NON-INTENDED MACHINE USE

- Do not operate the machine with the recovery tank open.
- Hands and feet must be kept on board while the machine is in motion.
- Do not make sudden turns, especially during downhill movements.



#### **WARNING:**

**Only ONE PERSON at a time is to be permitted on board the machine.**

### 2.1 - GETTING TO KNOW THE MACHINE (Fig. A)

- (1) Steering wheel with control panel
- (2) Ignition key
- (3) Seat
- (4) Operator presence sensor
- (5) EMERGENCY push-button, to stop immediately all functions
- (6) Foot rest
- (7) Accelerator pedal
- (8) Rear wheels
- (9) Operating light (optional)
- (10) Flashing light (optional)
- (11) Recovery water tank
- (12) Recovery water tank cover
- (13) Clean water tank
- (14) Plug
- (15) Recovery water drain hose
- (16) Squeegee water aspiration hose
- (17) Clean water drain hose
- (18) Clean water tank level tube

- (19) Brushes deck
- (20) Squeegee
- (21) Document compartment
- (22) Water filter
- (23) Traction and directional wheel
- (24) Squeegee support hook
- (25) Recovery tank support peg

### 3.1 - UNPACKING (Fig. B)

Once the packaging has been removed as indicated in the instruction sheet on the packaging itself, check the integrity of the machine and all the components supplied.

If any obvious damage is found, contact your local dealer and carrier within 3 days of receipt.

- Remove the envelope and boxes (26) containing the supplied accessories:
  - (20) Squeegee.
  - (32) N ° 2 brushes.
- Lift the tank unit and take the documentation from the appropriate envelope:
  - (33) Machine use and maintenance manual.
  - (34) Battery charger instruction manual (if present).

#### 3.1.a - Battery installation (Fig. A)

- Lift the recovery tank carefully (11).
- Depending on the configuration (4 6 V batteries, 2 12 V batteries, 1 package of 24 batteries), position and connect the batteries as shown in figure, using the cables and plugs provided.
- Lower the recovery water tank carefully (11).



#### **NOTE:**

*The batteries must be installed and connected by qualified personnel.*

### 3.1.b - Unloading the machine from the wooden pallet (Fig. B)

- Remove the wooden block (27) positioned in front of the front wheel.
- Place the ramp (28) in front of the wooden pallet as indicated in the instruction sheet on the packaging.
- Sit on the seat (3) in driving position.
- Turn the start key (2) on "ON".

- Press the travel direction button (31) 

, with the  " icon on the display, then press the accelerator pedal (7) and step off the pallet (29) carefully.

## 4.1 - ASSEMBLY COMPONENTS

### 4.1.a - Squeegee installation (Fig. C)

- Insert the squeegee (20) into its support plate (35) and secure it with the levers (36) by rotating them clockwise.
- Connect the suction tube (16) to the squeegee's intake opening (37).

### 4.1.b - Brushes installation

- See procedure in the "13.4.a - Brushes replacement (Fig. M)" paragraph.

## 5.1 - CHARGING THE BATTERY



### DANGER:

Charge the batteries in rooms which are well-ventilated and comply with applicable regulations in the country of use.

For safety-related information, follow what is described in chapter 1 of this manual.



### WARNING:

For information and warnings about the battery and on board battery charger (if present) follow what is described in the battery charger manual enclosed with this document.

When the machine leaves the factory, it is calibrated to operate with gel batteries. If other types of batteries are installed, see the paragraph "Parameter setting".

The use of gel batteries with calibration for acid or other batteries is prohibited.

(Only for without on-board battery charger versions) The appliance must only be supplied at SELV (safety extra-low voltage) external battery chargers.



### NOTE:

*(For GEL batteries only) 10 hours are needed for complete battery charging. Avoid partial recharges.*

Charge the batteries at the end of each job or at least when the battery symbol  on the display (41 Fig. F) starts flashing.

- Drive the machine to the battery charging station.
- Lift the recovery water tank (11) making sure it is empty.

### 5.1.a - Charging the battery with an external battery charger (Fig. G)

- Check the function of the battery charger consulting the corresponding Manual.
- The nominal voltage of the battery charger must be equal to 24 V.
- Take connector (39) from the appropriate housing (38) and connect it to the external battery charger.
- Connect the battery charger to the electrical network.
- When the recharging is finished, disconnect the battery charger from the network and from connector (39).
- Lower the recovery water tank carefully (11).

### 5.1.b - Battery charging with on-board battery charger (if present) (Fig. G)

- From the appropriate housing (38), take and connect the plug of the battery charger cable (40) to the electrical network (the network voltage and frequency must be the same as the corresponding values of the battery charger, shown in the machine's registration plate).



#### **NOTE:**

When the battery charger is connected to the electrical mains, all machine functions are automatically disabled.

- On the display (41 Fig. F), when the segments light up in sequence on the battery symbol, this means that the battery charger is charging the batteries.
- When all the segments in the battery symbol are lighted up steadily, the battery charging cycle has ended.
- Disconnect the battery charger cable (40) from the electrical network and insert it into the appropriate housing (38).
- Lower the recovery water tank carefully (11).

## 6.1 - MACHINE CONTROLS

### 6.1.a - Control panel (Fig. F)

#### (2) Ignition key

- Turned in a clockwise direction to "ON" it powers the circuits, enabling machine operation.
- Turned in an anti-clockwise direction to "OFF" it disconnects power to the circuits and can be removed.





#### (30) Buttons for maximum speed adjustment

It is possible to adjust the maximum travel speed using buttons (30a) "+" and (30b)



- Pressing the accelerator pedal (7) completely, the speed will be adjusted proportionally to the maximum set value.
- When all speed symbols " are lighted on the display (41), the accelerator pedal (7) is inhibited and the machine remains stopped.

#### (31) Travel direction button

- By pressing the button (31) "", with the "" icon on the display, the machine proceeds in forward gear.
- By pressing the button in (31) "", with the "" icon on the display, the machine proceeds in reverse and the reverse buzzer is activated.



#### **NOTE:**

The maximum backward speed can be set, as in the forward travel, with buttons (30).

## (41) Display

- See the specific chapter.

## (42) "Ready to go" button

- Pressing the button (42) on the display,

the icon  shows up and the following functions are started according to a standard setting:

- Lowering of the brushes deck and rotation of the brushes.
  - Lowering of the squeegee and starting of the suction device.
  - Work speed = 3<sup>^</sup> notch (3,6 km/h).
  - Water flow = 3<sup>^</sup> notch.
  - Chemical agent = 3<sup>^</sup> notch (1%).
  - Suction = normal (100%).
  - Brushes pressure = normal.
- With this standard function activated it is possible to press any work button for any modification or adjustment.



If necessary, when a modification is set in the work functions, it is possible to save it acting as indicated below:

- Press and keep pressed the button (42) for 3 seconds; the saving confirmation is indicated on the display (41) by the flashing of "UPLOADED".
- To deactivate the new setting and return to the standard setting values, press again and keep pressed the button (42) for 3 seconds; the confirmation is indicated on the display (41) by the flashing of "RESET".

## (43) ECO button

- When pressing the button (43) on the display in the work phase, the icon  shows up, the parameters of water, chemical agent, suction and holder pressure assume the following values:
  - Water flow = 3<sup>^</sup> notch.
  - Chemical agent = 3<sup>^</sup> notch (1%).
  - Suction = silent (50%).
  - Brushes pressure on the floor = normal.

## (44) Suction / Silent operation button

- Pressing the button (44) the suction device turns on and the icon  shows up on the display and, if the forward gear is engaged or if the machine is in neutral, the squeegee lowers.
- With the suction function turned on, the next time you press the button (44) the speed of the suction turbine is reduced, significantly reducing the noise emitted by the machine; with the function enabled the  icon appears on the display.
- The next time the button (44) is pressed, the vacuum cleaner stops, the squeegee raises and the vacuum system icons on the display go off.



### NOTE:

With the machine stopped, the squeegee lowered and the start key (2) in the "ON" position, after a period of inactivity the squeegee will automatically raise.

## (46) Brushes / extra pressure mode button

- Pressing the button (46), the brushes deck lowers and the icon  shows up on the display.
- The brushes start rotating when the accelerator pedal is pressed, they stop when the accelerator pedal is raised.



### NOTE:

The brushes rotate both in forward and reverse mode and with speed adjustment (30) at "0".



### NOTE:

With the machine stopped, the deck head lowered and the brushes stopped with the start key (2) in the "ON" position, after a period of inactivity the brushes deck head will automatically raise.

- With the brushes on the ground and working, the next time you press the button (46) the extra pressure is activated; with the function enabled the “” icon appears on the display.



**NOTE:**

The extra pressure function is equipped with a safety system that automatically recognises an excessive current absorption of the brushes motors and it's able to automatically change the lowered brushes pressure taking it to the most useful position.



- The next time the button (46) is pressed, the brushes stop, the brushes deck head raises and the brushes system icons “” on the display go off.



**NOTE:**

Each time the brushes deck lifts (rest position), the brushes pressure sets at the minimum value.

### (48) Chemical agent dosing button (if present)



- Pressing the button (48) the icon “” shows up on the display, and the dosing of the chemical agent is prepared. The dosing pump operation is commanded by the accelerator pedal pressed.
- Pressing the button (48) repeatedly, the quantity of chemical agent increases; up to the maximum quantity viewed on the display of icon “”. By pressing the button (48) the function is deactivated and the icon turns off on the display.



**NOTE:**

In case of emptying of the chemical agent dosing system, after replacing the tank, hold and hold the button (48) pressed for at least 5 seconds to activate the air purge procedure lasting about 40 seconds; this function is activated only with the machine stopped, the start key (2) in the “ON” position and with the speed adjustment (30) at “0”.

### (49) Water flow button

- Pressing the button (49), the icon “” shows up on the display and the opening of the water solenoid valve is prepared. The operation of the same is commanded by the accelerator pedal pressed.
- Repeatedly press the button (49) to increase the water quantity; when the maximum quantity is reached, it'll be shown on the display by the icon “”. If the button (49) is pressed again the function will be disabled.

### (50) Acoustic warning button

### (51) Rotating flashing light button

### (52) Operating light button

## 6.1.b - Accelerator pedal (Fig. A)

- Pressing the accelerator pedal (7), the machine moves either forward or backward, according to the travel direction button that was pressed.
- The speed can be adjusted by a higher or lower pressure on the accelerator pedal.
- Release the accelerator pedal (7) to slow down the machine until it stops. After a few seconds after the machine is still the parking brake automatically activates; this brake will be disabled when the accelerator pedal (7) is pressed with forward or reverse motion on.

## 7.1 - DISPLAY (Fig. F)

With the machine running, the following icons show up on the display (41):

### Battery

Indicates the charge status of the batteries:







 Battery charged

 Battery discharged



### Maximum advance speed

With buttons (30a) “+” and (30b) “-” the maximum speed attainable by the machine is set with the accelerator pedal (7) completely pressed:

					
km/h - 0	1,2	2,4	3,6	4,8	6,0

### Travel direction

The travel direction arrow indicates the selected advance function by acting on the button (31) “”.

### “Ready to go”

It is viewed on the display when the button (42) “” is pressed.

### ECO mode

Is shown when the ECO function is active through the button (43) “”.

### Suction device working

Is viewed on the display when the button (44)

“” is pressed, indicating that the suction device is on and the squeegee is low.

### Silent operation

With the suction device on.

The next time the button (44) “” is pressed, appears on the display, indicating that the suction device is working with a reduced and silent speed.



### Brushes rotation

Is viewed on the display when the button (46)

“” is pressed, indicating that the brush rotation is enabled.

### Extra-pressure





With brushes rotation enabled. The subsequent pressing of the button (46) “

” enables the brushes extra pressure, it is indicated with the “” icon.

### Detergent dispenser (if present)

Is viewed on the display when the button (48)

“” is pressed. Press the button to increase or reduce the percentage of detergent being dosed:

				
0,2%	0,5%	1%	2%	3%

### Preparation of the water flow

Is viewed on the display when the button

(49) “” is pressed, indicating that the water flow solenoid valve is enabled.

When the water level in the tank is at a mini-

mum, the icon “” is viewed in full screen combined with the acoustic signal. Replenish the water tank (13) as indicated in the specific paragraph, then turn off and restart the machine

---



### **Absence of the operator on the driver's seat**

This icon warns when the operator is not correctly seated on the driver's seat and blocks all the machine functions.

---



### **Maximum liquid level in recovery tank**

This displays when the fluid in the recovery tank has reached the maximum level.

---



### **Accelerator pedal pressed**

This icon inserts when the machine starts indicating a wrong starting operation sequence, to remove the alarm release the accelerator pedal (7 Fig. A).

## **8.1 - EMERGENCY**

The emergency button (5 Fig. A) is located in an easily accessible position for the operator. It must be firmly pressed in case of an immediate need to stop the machine in all its functions.

To reactivate the machine functionality, pull the emergency button until it disengages and resets.



### **WARNING:**

**Only press the emergency button (5) with the machine running in case of a real need, do not use this procedure to stop the machine, this may cause also serious faults in the same.**

## **9.1 - SAFETY DEVICES (Fig. A)**

The machine is equipped with the following safety functions:

### **Operator presence sensor (4)**

It blocks all the machine functions when the operator is not present in the driving seat.

### **Anti-skid safety system**

This system reduces the speed when turning and when the machine tilts laterally to avoid sudden skids, this increasing the machine stability in any condition.

### **Electromagnetic brake**

It is built-in the rear driving wheels (23) and keeps the machine braked when the machine is off or stopped.

## **10.1 - FILLING THE TANK (Fig. D)**



### **WARNING:**

**Only add clean mains water to the tank at a temperature no greater than 50°C.**

- Using the extractable pipe (52) fill water into the tank (13) until it is replenished.
- Do not fill the tank completely, use the level tube (18) as a reference.
- Or, if available, open cap (14) and use the waterstop intake (53, if present).



### **WARNING:**

**Always visually check the fill level to avoid the risk of floor wetting.**

- At the end of the tank replenishment close the cap (14).



**NOTE:**

For machines without the chemical kit, fill the tank (13) with clean water and mix it with the chemical detergent.

Always follow the dilution instructions indicated in the label of the chemical product packaging, to prepare the detergent solution.

## 10.2 - DETERGENT CHEMICAL TANK (if present) (Fig. E)



**NOTE:**

Use non-foamy detergents only. For the quantities, follow the instructions provided by the detergent manufacturer according to the type of dirt.

- Raise the recovery tank (11).
- Check that in the tank (54) there's the product necessary for the working day.

In case of tank replacement work as indicate below:

- Remove the cap (55), extract the tank (54) and insert a new 5 litres one then insert the cap (55) using the small suction pipe.



**DANGER:**

**In case of contact of the detergent with the eyes and skin, or in case of ingestion, please refer to the safety and application bulletin of the detergent manufacturer.**



**NOTE:**

The tanks (54) to use are the standard 5 litres type which can be found on the market.

- Lower the recovery water tank carefully (11).
- Carry out the air purge (see the procedure on item "Chemical agent dosing button").

## 11.1 - OPERATION (Fig. A-F)

### 11.1.a - Checks before use

- Check that the recovery tank's drainage tube (15) is properly connected and sealed.
- Check that the squeegee's water suctioning tube (16) is properly inserted into the recovery tank.
- Check that the coupling (37) on the squeegee (20) is not obstructed and that the tube (16) is properly connected.
- Check the charge status of the batteries by turning the start key (2) to its "ON" position and checking the charge indication on the display (41).

### 11.1.b - Preparing the machine and choosing the cycle

- Sit on the driving position.
- The machine can perform 4 working cycles:

#### Washing, brushing, drying cycle:

- Press the button "Ready to go" (42)  to prepare the detergent flow, the brushes rotation and the start of the suction device.

#### Drying only cycle:



- To perform only the drying cycle press the button (44) , the aspirator activates.

#### Brushing only cycle:

- To perform only the brushing cycle press the button (46) , the brushes rotation is prepared.

- Brushes rotation starts when the machine, with the accelerator (7) pressed, starts moving forward or backward, or with the accelerator pressed and setting the forward speed to "0".

### Washing, brushing cycle:

- Press the button (46)  to prepare brushes rotation and press the button (49)  to prepare water supply.
- The brush rotation and the water flow start when the accelerator pedal is pressed with the forward or backward gear, or with the setting of the advance speed at least on the 1st notch.

### 11.1.c - Using the machine



#### **DANGER:**

**Be extremely careful when using the machine on ramps in order to avoid roll over or situations which may cause the machine to lose its balance.**



#### **DANGER:**

**Avoid sudden sharp turns. Turn the wheel from lock to lock only at low speed, always considering ground conditions.**

- Turn the start key (2) to "ON"; in the first 2 second after turning on, the display (41) indicates the type of batteries installed and the machine work time.
- Select the type of work cycle to be followed.
- Insert the desired work speed acting on buttons (30).
- Activate the flashing light (10, optional) and the work light (9, optional).
- Use the accelerator (7) to begin the cleaning operations.



#### **NOTE:**

Release the accelerator to stop the rotation of the brushes and the dispensing of water.



#### **NOTE:**

Proper floor cleaning and drying is performed by driving the machine forwards. When driving in reverse, the squeegee is raised and the suction unit, for removing the water from the floor, is deactivated.

- Adjust the washing solution quantity with the button (49)  if its necessary.
- Check the charge status of the batteries on the display (41).

### 11.1.d - End of use and shutdown

- Once all of the cleaning operations have been completed, shut off, in sequence, the rotation of the brushes and the suction unit, using the relative controls according to the type of cycle being employed.
- Turn the start key (2) to its "OFF" position.
- The parking brake automatically activates.
- Empty and wash out the recovery tank and the solution tank as indicated in the relative sections.



#### **NOTE:**

When the operator gets out of the machine the parking brake automatically activates.



#### **DANGER:**

**It is forbidden to park the machine on ramps.**

## 12.1 - DRAINING THE RECOVERY WATER (Fig. H)



### **DANGER:**

**Before lifting the recovery water tank (11) make sure it is empty.**

At the end of the washing cycle or when the recovery water tank (11) is full, it is necessary to empty the tank by proceeding as follows:



### **NOTE:**

To dispose of the recovery water, comply with the standards in force in the country in which the machine is used..

- Position the machine near to a drain outlet.
- Detach the pipe (15) from its proper hook, descending it to the floor over the discharge drain.
- Unscrew the cap (56) and discharge completely the recovery water contained in the tank.



### **NOTE:**

The amount of water that comes out can be modulated by pressing on the end of the tube (15).

- Tighten the cap (56) and replace the pipe (15) on its corresponding support.

## 13.1 - MAINTENANCE AND CLEANING



### **WARNING:**

**For information and warnings related to maintenance and cleaning operations please follow what is indicated in the “SAFETY WARNINGS FOR FLOORS WASHER-DRYER” annexed to this one.**

## 13.2 - OPERATIONS TO PERFORM DAILY

### 13.2.a - Emptying and cleaning the clean water tank (Fig. I)



### **WARNING:**

**At the end of the washing operations, it is compulsory to drain and clean the clean water tank (13) to prevent deposits or scaling.**

After draining the recovery water tank, drain the clean water tank (13) as follows:

- Position the machine over a drain outlet.
- Remove the hose (17) from the holding hooks and lay it down on the drain outlet; remove the cap (57) and drain all the water contained in the tank.
- Wash the inside of the tank, leaving the drain hose open and adding clean water through the top opening.
- Once finished cleaning, lift the tube (17), close it with its appropriate cap (57) and position it within its appropriate lodgings.

### 13.2.b - Cleaning the recovery water tank (Fig. J)



#### **WARNING:**

**At the end of the washing operations, it is compulsory to clean the recovery water tank to prevent deposits or scaling and the proliferation of bacteria, odours or mould.**

- Lift the cover (12).
- Remove the dirt collection basket (58) and open its cover, then clean with running water, also removing eventual pieces of paper, wood, etc... that are clogging it.
- Remove and clean the suction filter (59) with running water.
- Leaving the discharge pipe (15 Fig. H) low and the cover removed, fill with water through the upper opening (60), then flush inside the tank until clean water flows out of the discharge pipe.
- Reassemble all parts working in the reverse order.

### 13.2.c - Squeegee cleaning (Fig. K)

In order to clean the squeegee correctly (20), it is necessary to remove it as follows:

- Disconnect the hose (16 Fig. C) from the squeegee (20).
- Release the levers (36 Fig. C) by rotating them anti-clockwise and remove the squeegee (20).
- Wash the squeegee and in particular the rubber blades (60) and the inside of the aspiration connector (56).



#### **NOTE:**

*Slf, during washing, it is clear that the rubber blades (60) and (61) are damaged or worn, it is necessary to replace them or turn them over.*

- Replace all the components in reverse order.

## 13.3 - OPERATIONS TO BE PERFORMED EVERY 3 MONTHS



### 13.3.a - Check the wear status of the steering chain (Fig. L)

- Check the wear and corrosion status of the chain (63) found beneath the machine near the front wheel.
- If the chain appears corroded, it must be replaced.
- Contact the technical assistance service.

## 13.4 - OPERATIONS TO PERFORM WHEN NECESSARY

### 13.4.a - Brushes replacement (Fig. M)

The brushes must be replaced whenever they appear worn or whenever their bristles are shorter than 2 cm. They must also be replaced based on the type of flooring to be cleaned; in order to replace them, perform the following operations:

- Insert a hand beneath the brush support unit (19). In order to detach the brush, turn it quickly and forcefully in the opposite direction from that in which it rotates during normal function.
- Place the new brushes beneath the brush support unit (19).
- Get into the driver's seat and turn the key (2 Fig. F) to its "ON" position.
- Position the advance speed on value "0".
- Press the button (46 Fig. F)  to enable the brush rotation; the brush group descends.
- Pressing the accelerator pedal (7 Fig. A), the brushes hub starts to rotate gripping the brushes, then release the pedal.
- Press the button (46 Fig. F) again  and turn the key (2 Fig. F) to the position "OFF".

### 13.4.b - Splash guard rubber adjustment (Fig. M)

Depending on the type of floor to be treated or after replacing the brushes, it may be necessary to adjust the height of the splash guard rubber (64).

To adjust it, act as follows:

- Turn the key (2 Fig. F) to the “**ON**” position.
- Press the button (46 Fig. F) “”, to lower the brush head (19), then turn the key (2 Fig. F) to “**OFF**”.
- Check the correct height of the splash guard rubber as shown in the figure.
- If necessary, manually act on the splash guard rubber to restore the correct height.

#### **NOTE:**

The correct height of the splash guard rubber is when, during operation and the brush head is lowered, the rubber itself is flush with the floor.

- At the end of the adjustment, restart the machine and press the button (46 Fig. F) “”, then turn the key (2 Fig. F) to “**OFF**”.

### 13.4.c - Replacing the squeegee rubber blades (Fig. K)

When it becomes clear that drying the floor is difficult or traces of water remain on the floor, it is necessary to check the wear on the squeegee rubber blades (20):

- Remove the squeegee unit (20) as indicated in the “Cleaning the squeegee” paragraph.
- Press the locking device (65) and open the handle (66).
- Remove the two rubber mounting strips (67) and remove the outer rubber (60).
- Loosen the two turnbuckles (68) and remove the locking bar (69) and the inside rubber (61).

#### **NOTE:**

When the rubber blades (60) or (61) are worn on one side, on one occasion they may be turned over.

- Replace or turn over the rubber blades (60) or (61) without inverting them.
- Replace all the components in reverse order.

#### **NOTE:**

Two types of rubber are available: Para rubber for all types of flooring and polyurethane rubber for workshop floors with oily residues.

### 13.4.d - Squeegee incidence adjustment (Fig. N)

- Start the machine and press the button (44 Fig. F) “”.
- Adjust the speed to maximum on the 1<sup>st</sup> notch with the buttons (30 Fig. F), press the accelerator pedal (7 Fig. A) and step away a few metres, then turn the machine off and on again.
- Use the threaded bar (70) to adjust the squeegee blades (60) and (61) contact with the floor. Turn it clockwise for increased contact and counter clockwise for less contact.

#### **NOTE:**

When the squeegee is making proper contact with the floor, there will be no streaking on the floor during machine function and the entire length of the squeegee will be in contact with the floor.

### 13.4.e - Squeegee pressure adjustment (Fig. O)

Depending on the type of floor to be treated or after replacing the squeegee rubbers, it may be necessary to adjust the squeegee floor pressure. To adjust it, act as follows:

- Lift the recovery water tank (11) making sure it is empty.
- Act on the adjustment screw (71) taking into account that:
  - Turning clockwise decreases the squeegee floor pressure.
  - Turning counterclockwise increases the squeegee floor pressure.
- At the end of the adjustment, carefully lower the recovery water tank (11).

### 13.4.f - Cleaning the clean water filter (Fig. P)

- Make sure that the tank (13 Fig A) is empty.
- Remove the cap (22) and take out the filter cartridge (72).
- Clean the filter cartridge (72) using running water.
- Reassemble everything proceeding in reverse making sure that the gasket (73) is placed correctly.

### 13.4.g - Battery compartment drain tap (Fig. A)

- Periodically check that there are no stag-nations of water in the battery compartment.
- If necessary, position the machine near a drain, unhook the tube and open the tap (74), then drain the liquids.



### WARNING:

**Where the use of lead-acid batteries is foreseen, pay close attention to any leakage of liquid from the batteries themselves, the associated risks and the regulations for the disposal of liquids hazardous substances.**

### 13.4.h - Checking the wear status of the three wheels (Fig. A)

- Check the wear status of the three wheels (8) and (23) periodically; if they appear worn or damaged, contact a technical service centre in order to have them replaced.



### DANGER:

**Operating the machine with worn or damaged wheels poses a danger to the operator as the machine could have less traction when turning.**

## 14.1 - PARAMETER SETTING (Fig. F)

### 14.1.a - OPERATOR parameters

It is possible for the operator to have access to the menu to set the following parameters:

- **Language**
- **Type of batteries**
- **Display - Contrast**
- **Display - Luminosity**



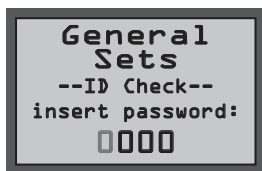

To have access to the menu act as follows:

Press and hold buttons (49) “” and (46)

“”, then turn the start key (2) to “ON” to view the following screens:



General Sets	General Sets
ID Check	Check
Insert password	Insert password

- Release the buttons pressed.
- Insert the 4-digit Password “0010” pressing the buttons (30a) “” or (30b) “” to change the number of the flashing digit.
- Press the button (43) “” to confirm and go to the next digit, to finally confirm the password and have access to the parameters list.
- Press the button (49) “” or (46) “” to scroll along the following screens:

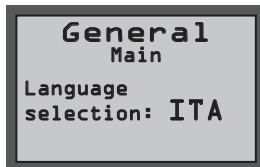

General Main	Principal configurations
Language selection	Language selection

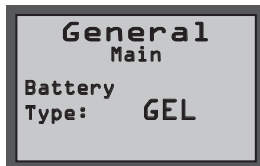

General Main	Principal configurations
Battery Type	Battery type selection



General Main	Principal configurations
Display Tune	Display contrast



General Main	Principal configurations
Display Brightness	Display brightness

## Language setting:

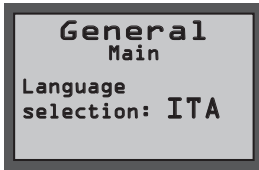

General Main	Principal configurations
Language selection	Language selection

- Select the language acting on buttons (30a) “+” or (30b) “-”, then press the button (43) “ECO” to confirm the selection;
- **ITA** = Italian
- **ENG** = English

## Setting the type of battery:

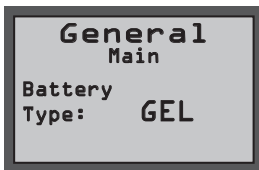

General Main	Principal configurations
Battery Type	Battery type selection

- Select the type of battery acting on buttons (30a) “+” or (30b) “-”, then press the button (43) “ECO” to confirm the selection;
- **GEL** = Gel battery
- **AGM** = AGM battery
- **WET** = ACID battery

## Display setting - Contrast:



General Main	Principal configurations
Display Tune	Display contrast

- Select the type of display contrast setting a value from “0 to 50” acting on buttons (30a) “+” or (30b) “-”, then press the button (43) “ECO” to confirm the selection.

## Display setting - Brightness:



General Main	Principal configurations
Display Brightness	Display brightness

- Select the type of display brightness by setting a value from “0 to 10” acting on the buttons (30a) “+” or (30b) “-”, then press the button (43) “ECO” to confirm the selection.



### **NOTE:**

*When the selected setting is confirmed, the machine restarts and the display (41) lights up in the work operation mode.*

## 15.1 - FUSE CHECK/REPLACEMENT



### **NOTE:**

*All machine electrical circuits are protected by auto-resettable electronic devices. The safety fuses activates only in case of serious damage.*

*It is recommended to have the fuses replaced by qualified personnel only.*

## 16.1 - ALARMS DURING THE FUNCTIONING (Fig. F)

When a machine malfunction takes place, the display (41) indicates the type of alarm according to the list shown below.

Consult the list and put in place the solution recommended to restore the correct functioning of the machine.

Should the recommended remedy fail to solve the problem, get in contact with the Technical Assistance Service.

ALARM	MEANING	SOLUTION
AL_1: General	Memory error	Restart the machine.
AL_2: General	Key malfunction	Turn off the machine for at least 10 seconds, then restart.
AL_3: General	Low voltage	Turn off the machine, check the status of the battery charge, fuses, contacts, cabling and connections, then restart the machine.
AL_4: General	Excessive voltage	Turn off the machine, check the fuses, contacts, cabling and connections, then restart the machine.
AL_6: General	Absence of communication with the command dashboard or display	Turn off the machine, check the contacts, cabling and connections, then restart the machine.
AL_7: General	Ffm communication	Turn off the machine, check the contacts, cabling and connections with the communication module and the functioning of the later, then restart the machine.
AL_8: General	Communication Internal 1 and 2	Restart the machine.
AL_9: General		
AL_10: General	Insert tag	Visualisation of missing "Tag" key: insert key.
AL_11: General	Invalid tag	Visualisation of wrong "Tag" key: change key or damaged key.
AL_12: General	Updating in progress...	Visualisation of remote parameter updating in progress: wait for the end of the updating.

<b>ALARM</b>	<b>MEANING</b>	<b>SOLUTION</b>
<b>AL_13: General</b>	<b>Turn off</b>	Visualisation of parameter updating completed: restart the machine.
<b>AL_41: Function</b>	<b>Overheating</b>	Turn off and wait for the machine to cool down. Check the consumption of the brush and suction device motors, the status of the ambient ventilation and restart.
<b>AL_42: Function</b>	<b>Power damaged</b>	Turn off the machine for at least 10 seconds, then restart.
<b>AL_44: Function</b>	<b>Relay fault</b>	The Relay/Remote switch does not close. Check the remote switch operation. In case of relay on board, if persists replace the board.
<b>AL_45: Function</b>	<b>Relay fault dc</b>	Detection of Relay/Remote switch closed at start. Check the status of the remote switch contacts. In case of relay on board, if persists replace the board.
<b>AL_46: Function</b>	<b>Over-current Brushes</b>	Turn off the machine, check the load (motor), the mechanics, the cabling and the connections, then look for the presence of a short circuit on the outlet, than restart.
<b>AL_47: Function</b>	<b>Over-current Suction device</b>	Turn off the machine, check the load (motor), the mechanics, the cabling and the connections, then look for the presence of a short circuit on the outlet, than restart.
<b>AL_48: Function</b>	<b>Over-current Water pump</b>	Turn off the machine, check the load (motor), the mechanics, the cabling and the connections, then look for the presence of a short circuit on the outlet, than restart.
<b>AL_49: Function</b>	<b>Current measurement Brush 1 and 2</b>	Check the consumption and the kind of application of the brush function, then restart the machine.
<b>AL_50: Function</b>		
<b>AL_52: Function</b>	<b>Current measurement Suction device 1</b>	Check the consumption and the suction device function, then restart the machine.
<b>AL_54: Function</b>	<b>Function Connections Brush 1 and 2</b>	Check the brush motors connection.
<b>AL_55: Function</b>		
<b>AL_57: Function</b>	<b>Connections Suction device 1</b>	Check the suction device motor connection.
<b>AL_59: Function</b>	<b>Unbalance</b>	Check the consumption of the brush motors.
<b>AL_60 : Function</b>	<b>Timeout Brush actuator</b>	Check wiring.

<b>ALARM</b>	<b>MEANING</b>	<b>SOLUTION</b>
<b>AL_61: Function</b>	<b>Current measurement Brush actuator</b>	Check the consumption of the actuator motor and the status of the mechanical moving parts.
<b>AL_62: Function</b>	<b>Over-current Brush actuator</b>	Turn off the machine, check the load (motor), the mechanics, the cabling and the connections, then look for the presence of a short circuit on the outlet.
<b>AL_63: Function</b>	<b>Limit switch Brush actuator</b>	Check the limit switch connections / status. Active control only for BTO version.
<b>AL_65: Function</b>	<b>Current measurement Squeegee actuator</b>	Check the consumption of the actuator motor and the status of the mechanical moving parts.
<b>AL_66: Function</b>	<b>Over-current Squeegee actuator</b>	Turn off the machine, check the load (motor), the mechanics, the cabling and the connections, then look for the presence of a short circuit on the outlet.
<b>AL_80: Traction</b>	<b>Overheating Traction motor</b>	Turn off and wait for the machine to cool down. Check the consumption and the kind of application of the traction, the status of the ambient ventilation, then restart.
<b>AL_85: Traction</b>	<b>Over-current Traction motor</b>	Turn off the machine, check the load (motor), the mechanics, the cabling and the connections, then look for the presence of a short circuit on the outlet, than restart.
<b>AL_86: Traction</b>	<b>Current measurement Traction motor</b>	Check the consumption and the kind of application of the traction function, then restart the machine.
<b>AL_87: Traction</b>	<b>Reading of Traction Motor</b>	Restart the machine.
<b>AL_88: Traction</b>	<b>Electric brake fault</b>	Turn off the machine, check the brake cabling, then restart.
<b>AL_89: Traction</b>	<b>Fault Accelerator Pedal</b>	Turn off the machine, check the connections and cabling, then restart.
<b>AL_90: Traction</b>	<b>Accelerator Pedal Pressed</b>	Release the pedal and restart the machine.
<b>AL_91: Traction</b>	<b>Encoder fault</b>	Turn off the machine, check the connections and cabling and restart.

## 17.1 - TROUBLESHOOTING

PROBLEM	CAUSE	SOLUTION
The machine does not start up when the key is turned.	Low battery.	Check that the battery is charged.
	Main fuse blown.	Replace the fuse found on the battery cable. (*)
	Defective key.	Change the key. (*)
The brushes doesn't turn.	Gearmotor fault.	Replace gearmotor. (*)
	Faulty Electronic board.	Replace the electronic board.
The suction unit does not function.	Recovery tank full.	Empty the tank.
	Defective turbine motor.	Replace the turbine motor. (*)
	Faulty Electronic board.	Replace the electronic board. (*)
The machine does dry properly, leaving traces of water on the floor.	Aspirator off.	Start up the aspirator.
	Aspiration tube blocked.	Check and if necessary clean the aspiration tube that connects the squeegee to the recovery tank.
	Recovery tank full.	Empty the recovery tank.
	Squeegee rubber blades worn.	Replace or turn over the squeegee rubber blades.
No water comes out.	Empty tank.	Fill the tank.
	Filter clogged.	Clean the filter.
	Pump solenoid valve not functioning.	Replace the solenoid valve pump. (*)
	Defective water pump.	Replace the water pump. (*)
	Faulty Electronic board.	Replace the electronic board. (*)

PROBLEM	CAUSE	SOLUTION
The machine does not move in working conditions.	Operator not properly seated in the driver's seat.	Sit properly in the driver's seat.
	Defective motorwheel.	Replace the motorwheel. (*)
	Faulty Electronic board.	Replace the electronic board. (*)
	Operator presence sensor malfunction.	Replace the operator presence sensor. (*)
Insufficient floor cleaning.	Unsuitable brushes or detergent.	Use brushes or detergents which are suitable for the type of floor or dirt to be cleaned.
	Brushes worn.	Replace the brushes.
The empty solution tank icon  keeps flashing.	Empty tank.	Fill the tank.
	Tap closed.	Open the tap.
	Faulty flowmeter.	Replace the flowmeter. (*)
There is stagnation of water in the battery compartment.	Faulty recovery tank level sensor.	Drain the water in the battery compartment with the appropriate pipe and tap.
		Check or replace the level sensor. (*)

(\*) Call customer service to request replacement.

## 18.1 - DEMOLITION OF THE MACHINE



### **DANGER:**

**Batteries and electrical parts are to be considered as special waste and must therefore be disposed of at appropriate collection facilities, as prescribed by the current regulations in the country of use.**

## 19.1 - WIRING DIAGRAM

### Legend:

<b>AC</b>	Accelerator
<b>BAT</b>	Batteries
<b>BC</b>	Battery charger
<b>BE</b>	Flashing light (optional)
<b>BRK</b>	Electromagnetic brake
<b>C1</b>	Battery connector
<b>EB1</b>	Functions table
<b>EB2</b>	Display
<b>EB3</b>	Command panel
<b>EV</b>	Solenoid valve
<b>F1</b>	Battery charger fuse (1A)
<b>F2</b>	Illumination fuse (if present) (3A)
<b>F3</b>	Horn fuse (1A)
<b>F4</b>	Flashing light fuse (if present) (1A)
<b>F5</b>	Solenoid valve fuse (5A)
<b>F6</b>	Brush deck actuator fuse (10A)
<b>F7</b>	Squeegee actuator fuse (10A)
<b>F8</b>	Electric brake fuse (7.5A)
<b>F9</b>	Water pump fuse (5A)
<b>F10</b>	Chemicals pump fuse (if present) (5A)
<b>F11</b>	Suction motor fuse (40A)
<b>F12</b>	Right brush motor fuse (40A)
<b>F13</b>	Left brush motor fuse (40A)
<b>F14</b>	Traction motor fuse (100A)
<b>HN</b>	Horn
<b>KEY</b>	Start key
<b>L1</b>	Work light (optional)
<b>MA</b>	Suction motor
<b>MAS</b>	Brush deck actuator motor
<b>MAT</b>	Squeegee actuator motor
<b>MS-DX</b>	Right brush motor
<b>MS-SX</b>	Left brush motor
<b>MT</b>	Traction motor
<b>PA</b>	Water pump
<b>PC</b>	Chemicals pump
<b>PE</b>	Emergency button
<b>S1</b>	Recovery water level sensor
<b>SW1</b>	Seat microswitch
<b>TE</b>	External remote switch

### Colour codes:

<b>BK</b>	Black
<b>BU</b>	Blue
<b>BN</b>	Brown
<b>GN</b>	Green
<b>GY</b>	Grey
<b>OG</b>	Orange
<b>PK</b>	Pink
<b>RD</b>	Red
<b>VT</b>	Violet
<b>WT</b>	White
<b>YE</b>	Yellow

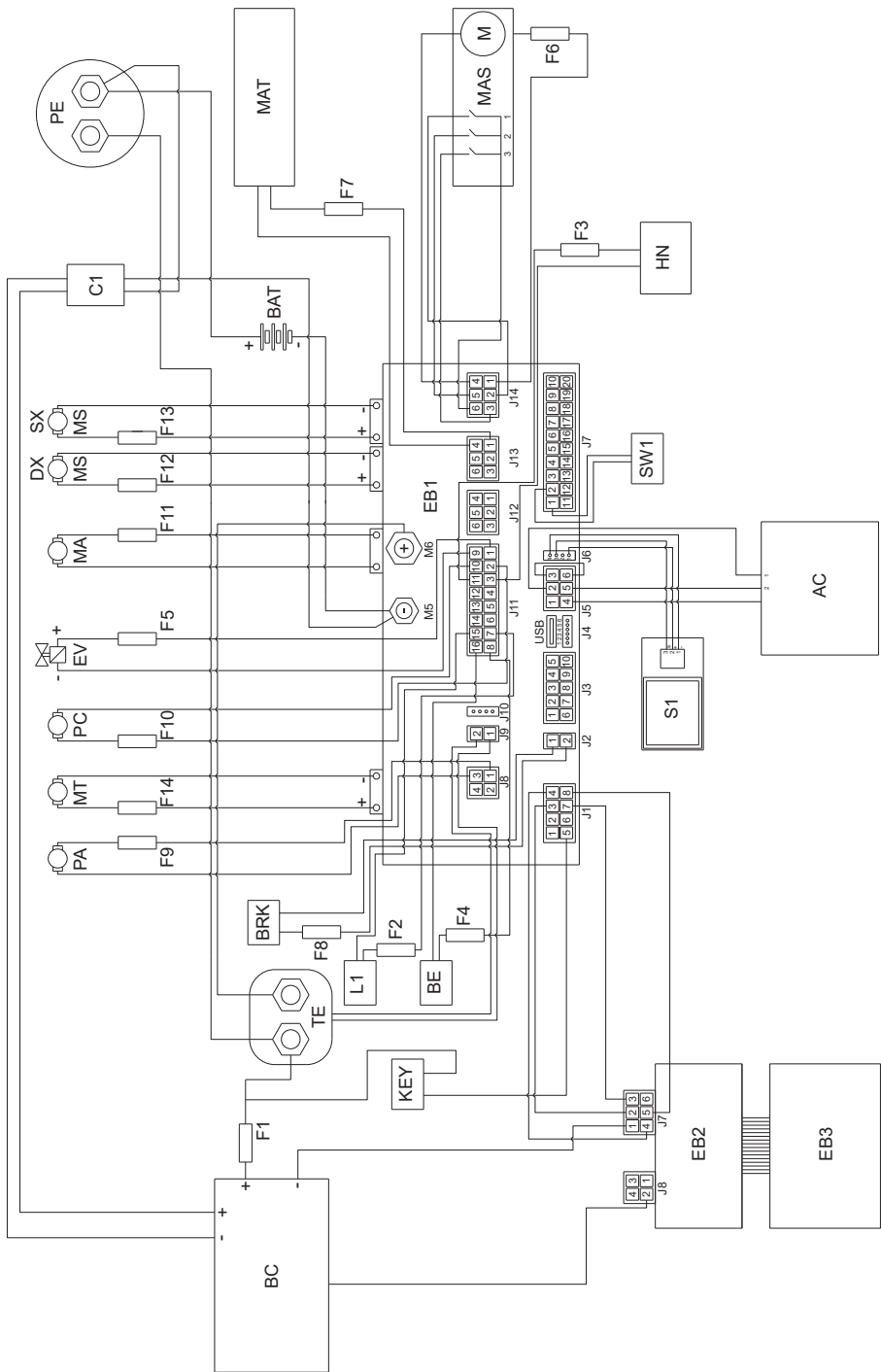







DEALER



**Riello Cleaning Machines S.p.A.**

Registered Office

Via Enrico Fermi, 43 - 37136 Verona (VR) - Italy

Headquarters

Via Circonvallazione, 5 - 27020 Dorno (PV) - Italy

P. +39 0382 848811 - F. +39 0382 84668 - M. info@riellocm.com



[ghibli.com](http://ghibli.com) - [wirbel.it](http://wirbel.it)

